



***Global Installation Guide for
Suntech Power Standard
Photovoltaic Module***

Version 20240101

Wuxi Suntech Power Co., Ltd.

Address: No.9 Xinhua Road, Xinwu District Wuxi, China 214028

Customer Service Hot Line: +86 400 8888 009 Fax: +86 510 8534 3321

E-mail: services@suntech-power.com, service.America@suntech-power.com

Or please contact our local representatives, details at www.suntech-power.com

..... 1

..... 2

..... 5

..... 6

..... 10

..... 27

..... 32

..... 34



“ ”

[power.com](http://www.suntech-power.com)

<http://www.suntech->

AC DC



(DC)

IEC61215 IEC61730
50V

II
240W

A



30V

30V

25

1.5

PV

STC

1000W/m²

3

12

2100N

KV46

Molykote EM

Pelicoat S-6

KE200

CX-200

Chemlok

TBP



IEC61730

10

MSDS



IEC 60721-2-1-

2-1

-40 ~40

-40 ~85

2000

0 50
50 500
500

3

" "

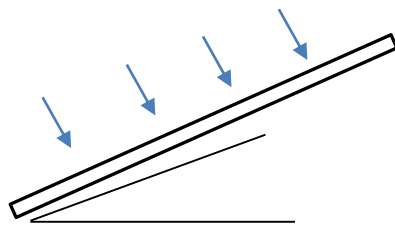

10°



1-	2-
3-	4-
5-	6-
7-	8-

1.

2. :
17 18

18
STP xxxxxxxxxxxxxxx2414

15 16
2014 24

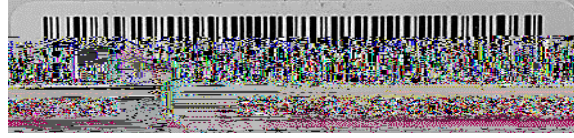

3.

x 1 2
“ ”

“ ”

“I_x”

“I_x”

I₂



		× ×
		± 2mm
C54	STPXXXS-C54/Umh	1722mm × 1134mm × 30mm
	STPXXXS-C54/Umhm	
	STPXXXS-C54/Umhb	
	STPXXXS-C54/Nsh	
	STPXXXS-C54/Nshm	
	STPXXXS-C54/Nshb	
C54	STPXXXS-C54/Pmh+	1722mm × 1134mm × 30mm
	STPXXXS-C54/Nsh+	
	STPXXXS-C54/Nshm+	
	STPXXXS-C54/Nshb+	
	STPXXXS-C54/Nshkm+	
	STPXXXS-C54/Nshtb+	
C72	STPXXXS-C72/Vmh	2278mm × 1134mm × 35(30)mm
	STPXXXS-C72/Vmhm	
	STPXXXS-C72/Vmhb	
	STPXXXS-C72/Nsh	
	STPXXXS-C72/Nshm	
	STPXXXS-C72/Nshb	
C72	STPXXXS-C72/Pmh+	2278mm × 1134mm × 35(30)mm
	STPXXXS-C72/Nsh+	
	STPXXXS-C72/Nshm+	
	STPXXXS-C72/Nshb+	
C78	STPXXXS-C78/Vmh	2465mm × 1134mm × 35mm
	STPXXXS-C78/Vmhm	
	STPXXXS-C78/Vmhb	
	STPXXXS-C78/Nsh	
	STPXXXS-C78/Nshm	
	STPXXXS-C78/Nshb	
C78	STPXXXS-C78/Pmh+	2465mm × 1134mm × 35mm
	STPXXXS-C78/Nsh+	
	STPXXXS-C78/Nshm+	
	STPXXXS-C78/Nshb+	

× ×
± 2mm

D66	STPXXS-D66/Wmh	2384mm × 1303mm × 35mm
	STPXXS-D66/Wmh	
	STPXXS-D66/Wmh	
	STPXXS-D66/Nsh	
	STPXXS-D66/Nfb	

D66	STPXXS-D66/Pmh+	2384mm × 1303mm × 35mm
	STPXXS-D66/Nsh+	

D60	STPXXS-D60/Wmh	2172mm × 1303mm × 35mm
	STPXXS-D60/Wmh	
	STPXXS-D60/Wmh	

D60	STPXXS-D60/Pmh+	2172mm × 1303mm × 35mm
-----	-----------------	------------------------

× ×
± 2mm

H48	STPXXS-H48-Nkh	1762mm × 1134mm × 30mm
	STPXXS-H48-Nfb	

H48	STPXXS-H48-Nsh+	1762mm × 1134mm × 30mm
	STPXXS-H48-Nth+	
	STPXXS-H48-Nfb+	
	STPXXS-H48-Nkh+	

H66	STPXXS-H66-Nkh	2382mm × 1134mm × 30mm
	STPXXS-H66-Nfb	

H66	STPXXS-H66-Nsh+	2382mm × 1134mm × 30mm
-----	-----------------	------------------------



60

20Mpa

10

10°

1

10Nm-14Nm

M8
450MPa

16Nm-20Nm M6

	M8	M6		
	2 1.5mm 16mm	2 1.5mm 12-18mm		
	8	6		
	M8	M6		

L=20mm

L=25mm

4

M6 M8

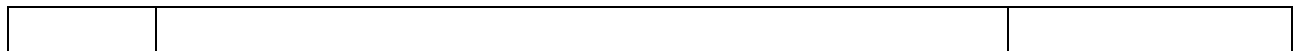

C54
H48

C72 C78 D60 D66 H66		1400mm
		M8
		790mm
		400mm
		M6

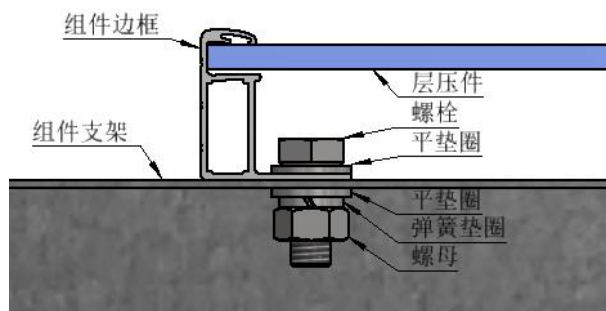

4

6005-T5

a b
e 3mm
10mm 12mm

c 80mm e 5mm

d 50mm

e

d

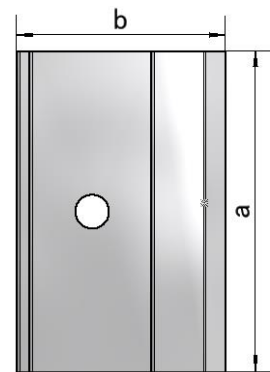
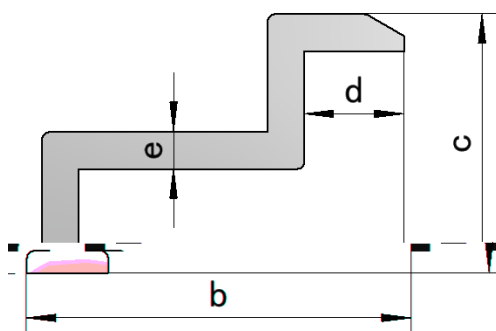
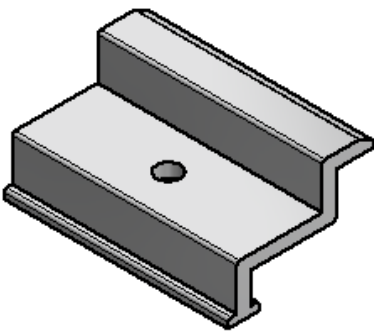

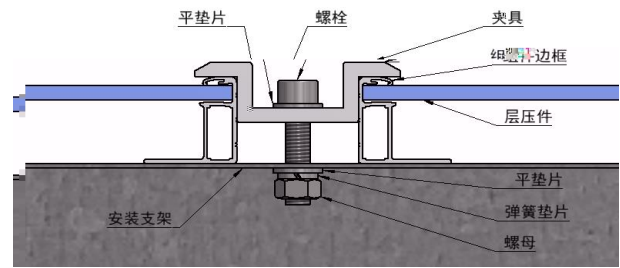
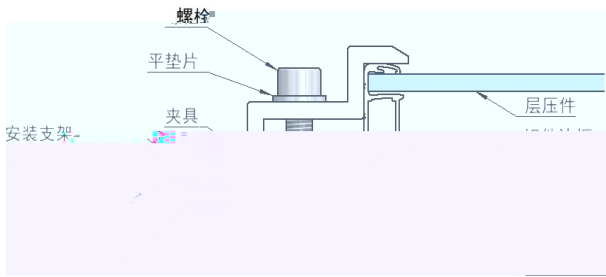
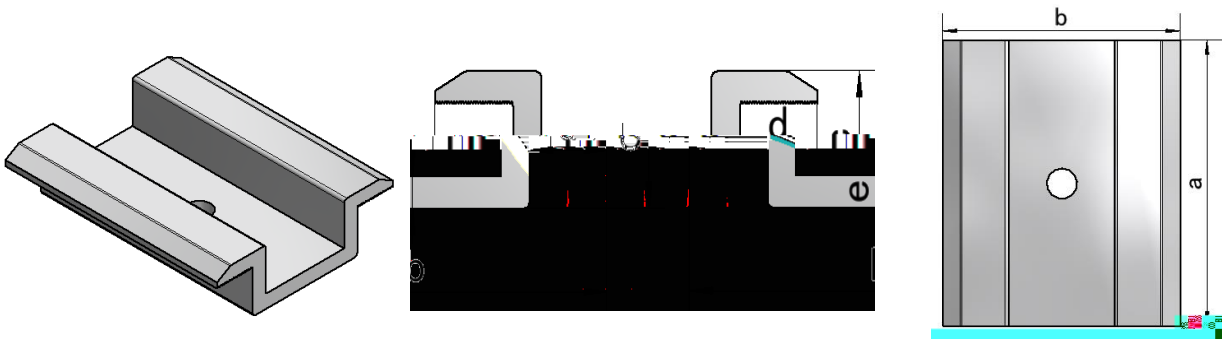

IEC 61215/61730

1.5

=1.5

*

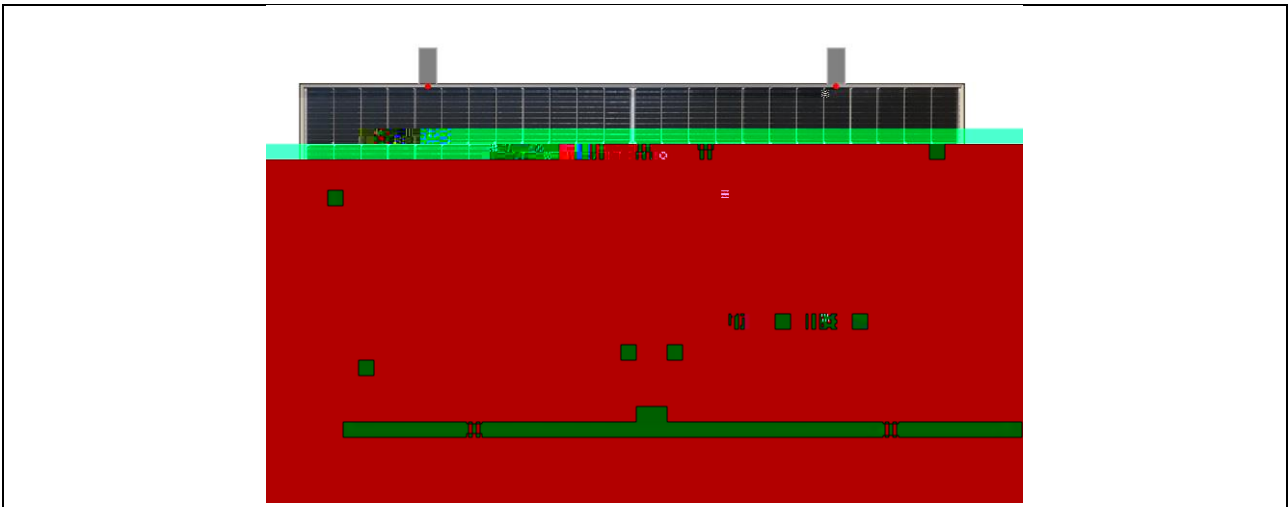

	Pa
C54	+5400/-2400
C54	+5400/-2400
C72	+5400/-2400
C72	+5400/-2400
C78	+5400/-2400
C78	+5400/-2400
D60	+5400/-2400
D60	+5400/-2400
D66	+5400/-2400
D66	+5400/-2400
H48	+5400/-2400
H48	+5400/-2400
H66	+5400/-2400
H66	+5400/-2400

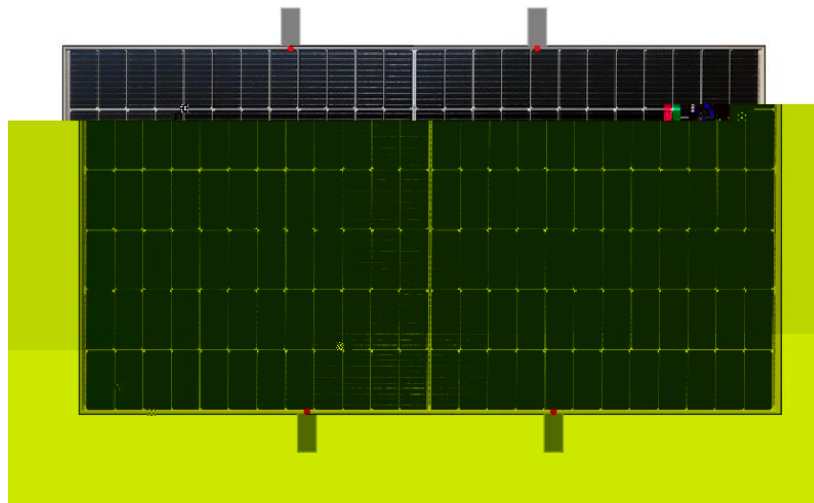

	Pa
C54	+3800/-2400
C54	+3800/-2400
C72	/
C72	/
C78	/
C78	/
D60	/
D60	/
D66	/
D66	/
H48	+3800/-2400
H48	+3800/-2400
H66	/
H66	/

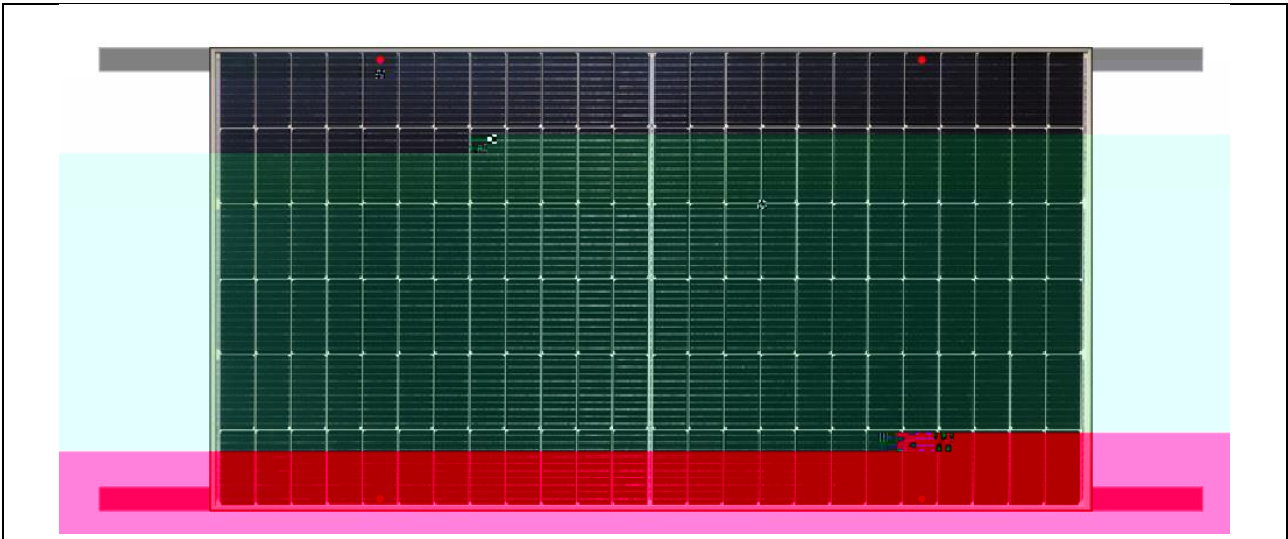

	Pa
C54	+4000/-2400
C54	+4000/-2400
C72	+3600/-2400
C72	+3600/-2400
C78	/
C78	/
D60	+3600/-2400
D60	+3600/-2400
D66	+3600/-2400
D66	+3600/-2400
H48	+4000/-2400
H48	+4000/-2400
H66	+3600/-2400
H66	+3600/-2400

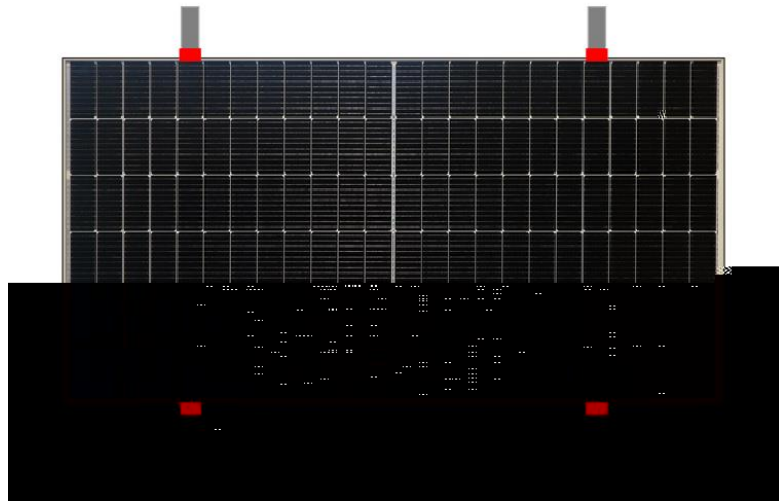

	L (mm)	A (mm)	Pa
C54	200	200	+5400/-2400
C54	200	200	+5400/-2400
C72	400	250	+5400/-2400
C72	400	250	+5400/-2400
C78	450	250	+5400/-2400
C78	450	250	+5400/-2400
D60	400	160	+5400/-2400
D60	400	160	+5400/-2400
D66	430	160	+5400/-2400
D66	430	160	+5400/-2400
H48	200	200	+5400/-2400
H48	200	200	+5400/-2400
H66	430	160	+5400/-2400
H66	430	160	+5400/-2400

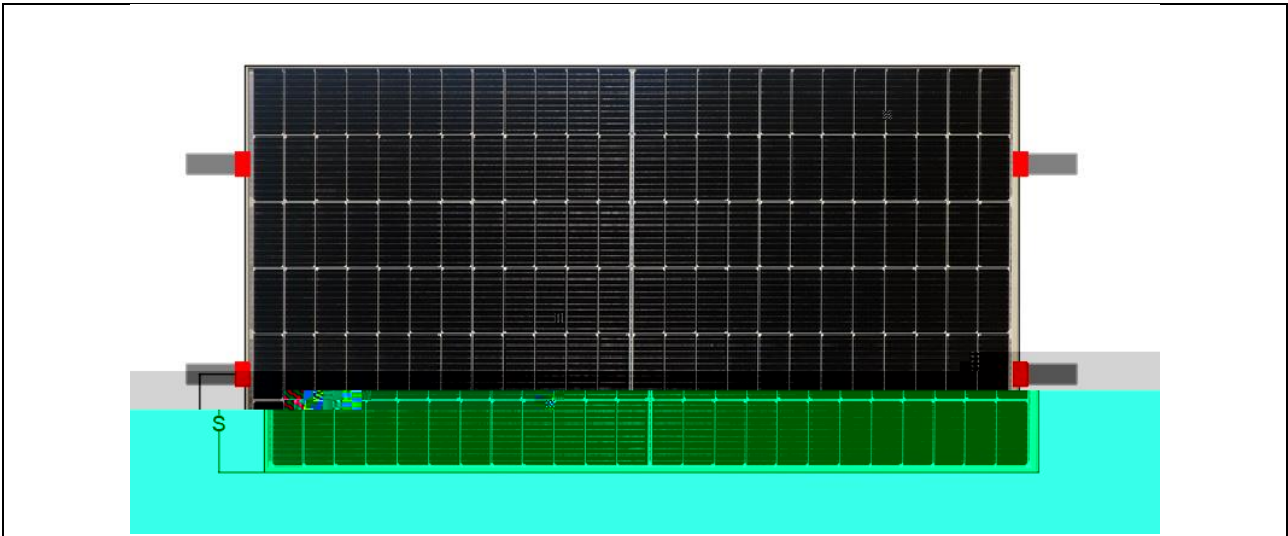

	S(mm)		Pa
C54	1/4	± 50	+5400/-1600
C54	1/4	± 50	+5400/-1600
C72	1/4	± 50	+5400/-800
C72	1/4	± 50	+5400/-800
C78	/	/	/
C78	/	/	/
D60	/	/	/
D60	/	/	/
D66	/	/	/
D66	/	/	/
H48	1/4	± 50	+5400/-1600
H48	1/4	± 50	+5400/-1600
H66	/	/	/
H66	/	/	/

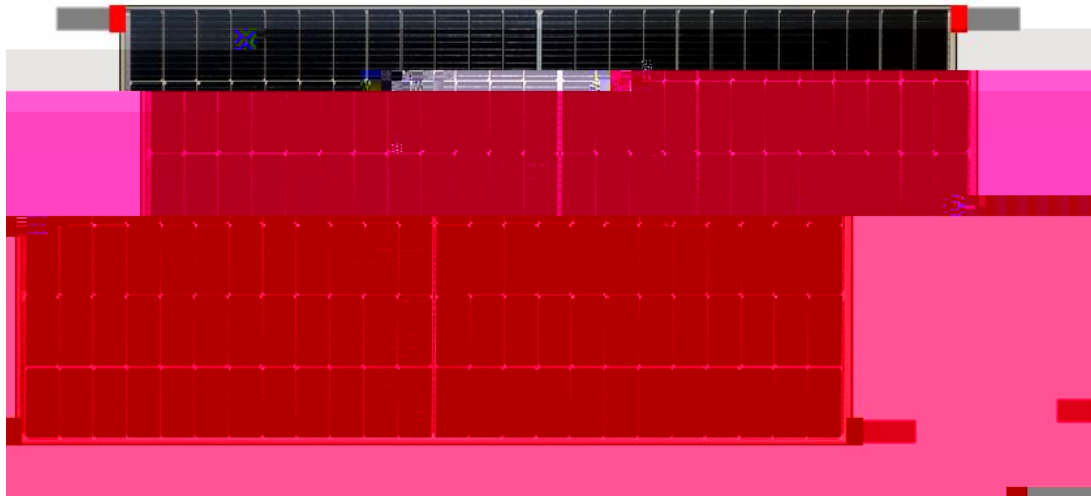

	Pa
C54	+2400/-1600
C54	+2400/-1600
C72	/
C72	/
C78	/
C78	/
D60	/
D60	/
D66	/
D66	/
H48	+2400/-1600
H48	+2400/-1600
H66	/
H66	/

	L (mm)	A (mm)	Pa
C54	200	100	+4000/-2400
	300	300	+3200/-2400
C54	200	100	+4000/-2400
	300	300	+3200/-2400
C72	400	150	+3600/-2400
C72	400	150	+3600/-2400
C78	/	/	/
C78	/	/	/
D60	400	100	+2800/-2400
D60	400	100	+2800/-2400
D66	400	150	+3600/-2400
D66	400	150	+3600/-2400
H48	200	100	+4000/-2400
	300	300	+3200/-2400
H48	200	100	+4000/-2400
	300	300	+3200/-2400
H66	400	150	+3600/-2400
H66	400	150	+3600/-2400

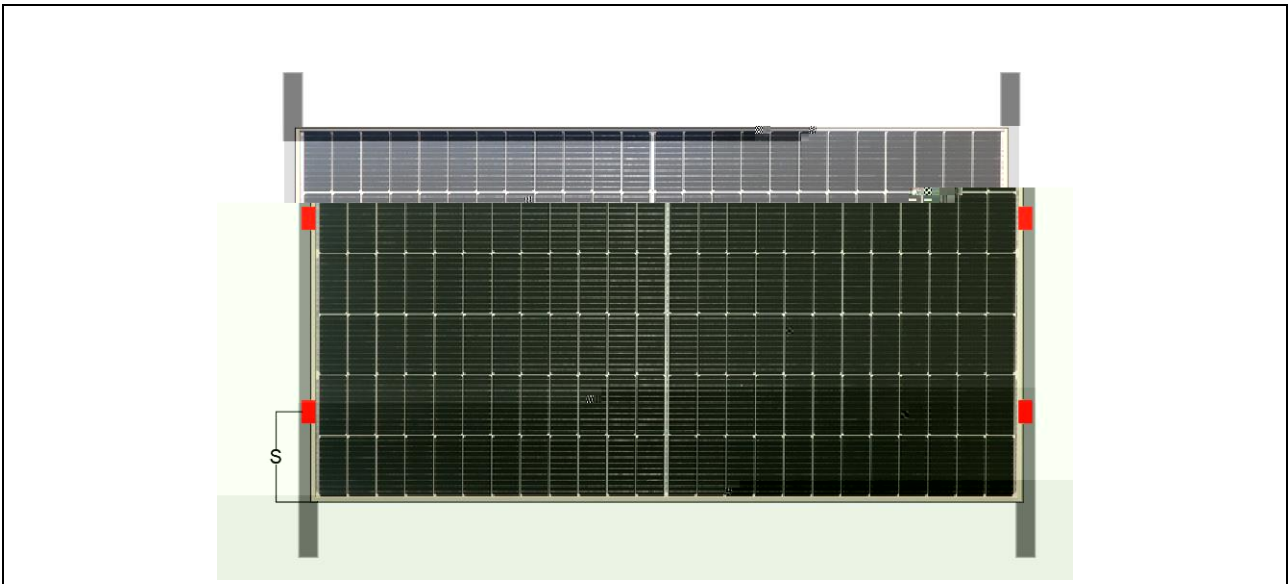

	S(mm)	Pa
C54	1/4 ± 50	+1600/-1600
C54	1/4 ± 50	+1600/-1600
C72	/	/
C72	/	/
C78	/	/
C78	/	/
D60	/	/
D60	/	/
D66	/	/
D66	/	/
H48	/	/
H48	/	/
H66	/	/
H66	/	/

	A1 (mm)	A2 (mm)	Pa
C54	100	80-380	+6000/-3800
C54	100	80-380	+6000/-3800
C72	100	300-500	+6000/-3600
C72	100	300-500	+6000/-3600
C78	/	/	/
C78	/		

	S(mm)	A1(mm)	Pa
--	-------	--------	----

C54

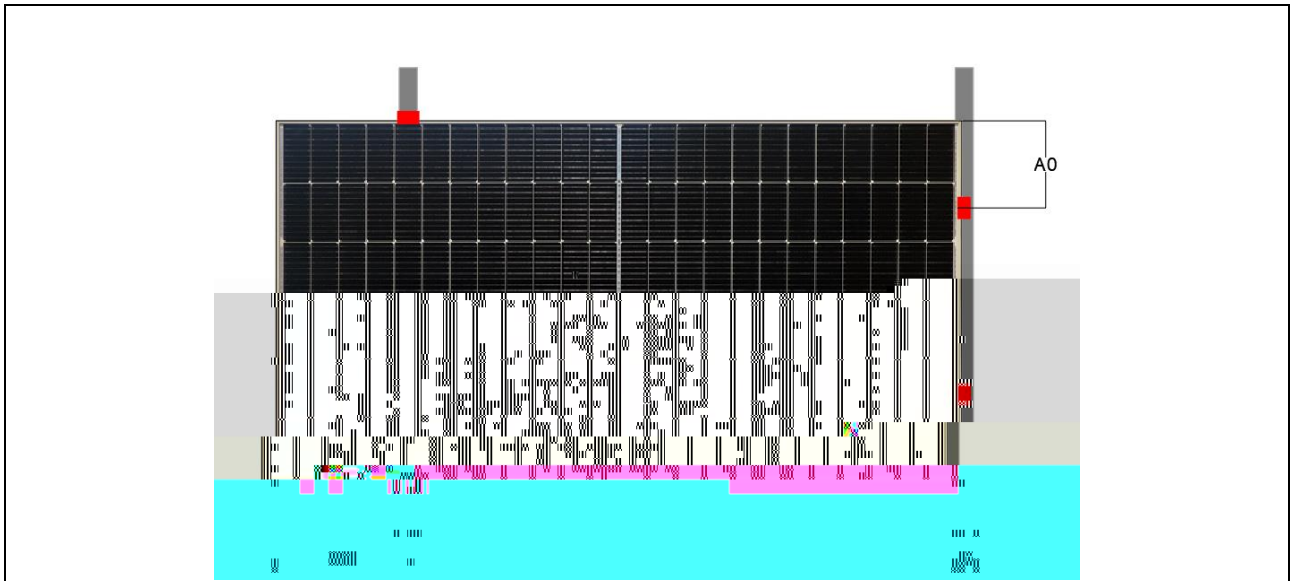

	A(mm)	A0(mm)		A1(mm)	Pa
C54	40	1/4	± 50	280-420	+2400/-2400
C54	40	1/4	± 50	280-420	+2400/-2400
C72	40	1/4	± 50	600-800	+2400/-2000
C72	40	1/4	± 50	600-800	+2400/-2000
C78	/	/	/	/	/
C78	/	/	/	/	/
D60	/	/	/	/	/
D60	/	/	/	/	/
D66	/	/	/	/	/
D66	/	/	/	/	/
H48	40	1/4	± 50	320-460	+2400/-2400
H48	40	1/4	± 50	320-460	+2400/-2400
H66	/	/	/	/	/
H66	/	/	/	/	/

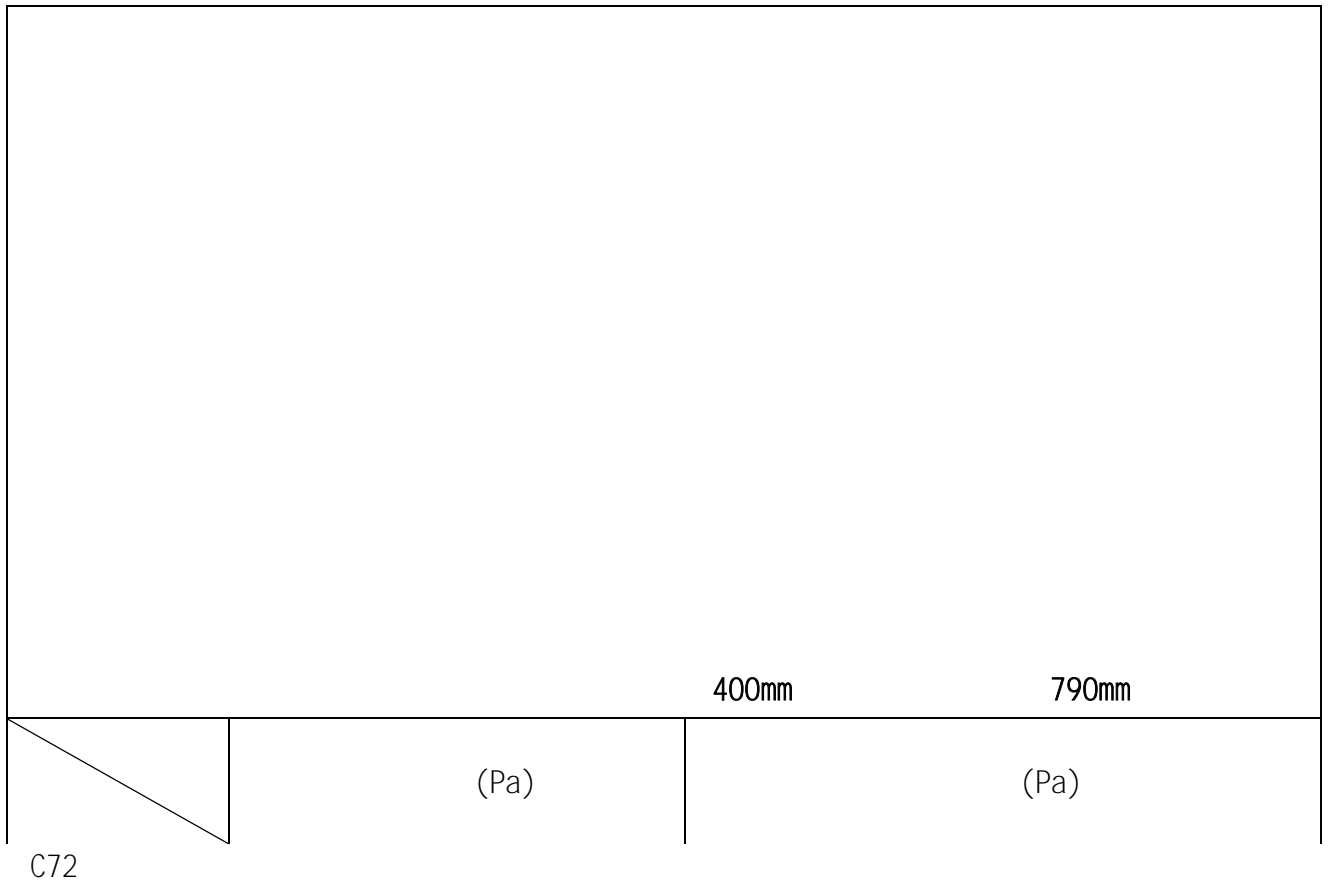

400mm (A1, A2, A3, A4) 790mm
 B1, B2, B3, B4
 16mm

		Pa
C72	B1, B2, A3, A4	+1900/-1900
	B1, B2, B3, B4	+2600/-2200
C78	/	/
D60	B1, B2, A3, A4	+1800/-1600
	B1, B2, B3, B4	+2000/-1800
D66	B1, B2, A3, A4	+2400/-2100



(IP65/67/68).

600 1000 1500

4mm²

:

68mm

MC4

H4

STP-XC4

TCABLE01S

/ /

IEC 62446 / IEC 60364-6

)

(

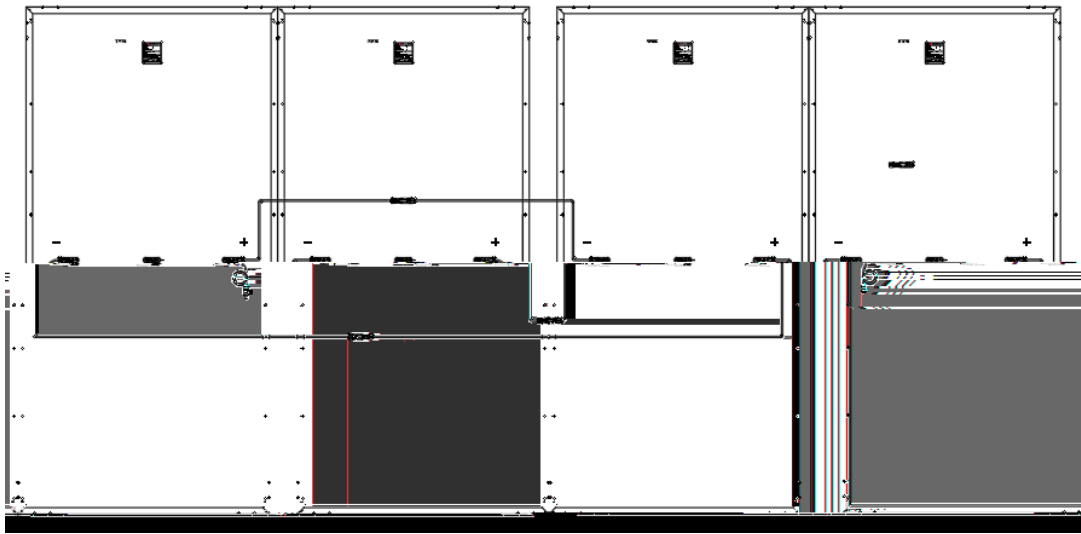
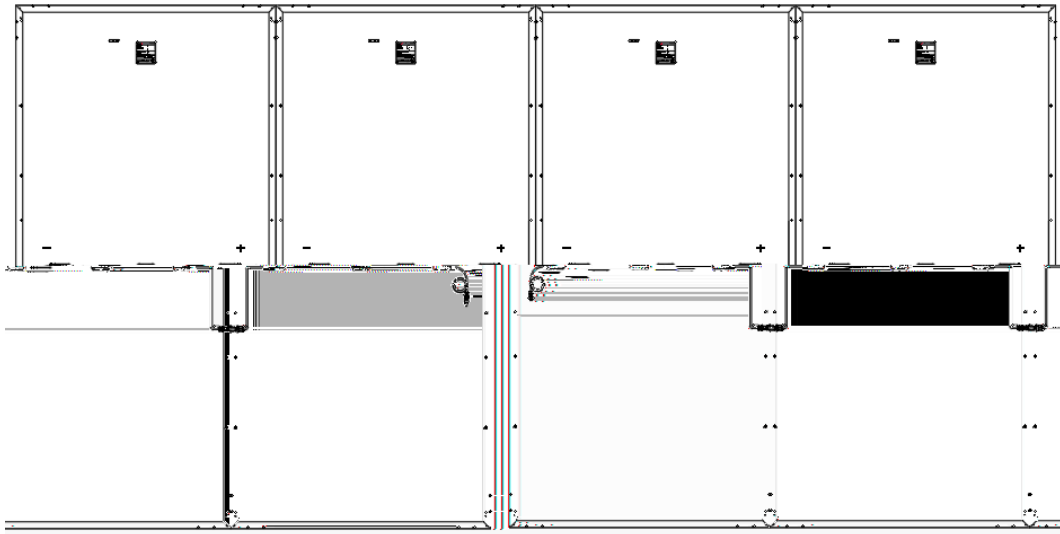

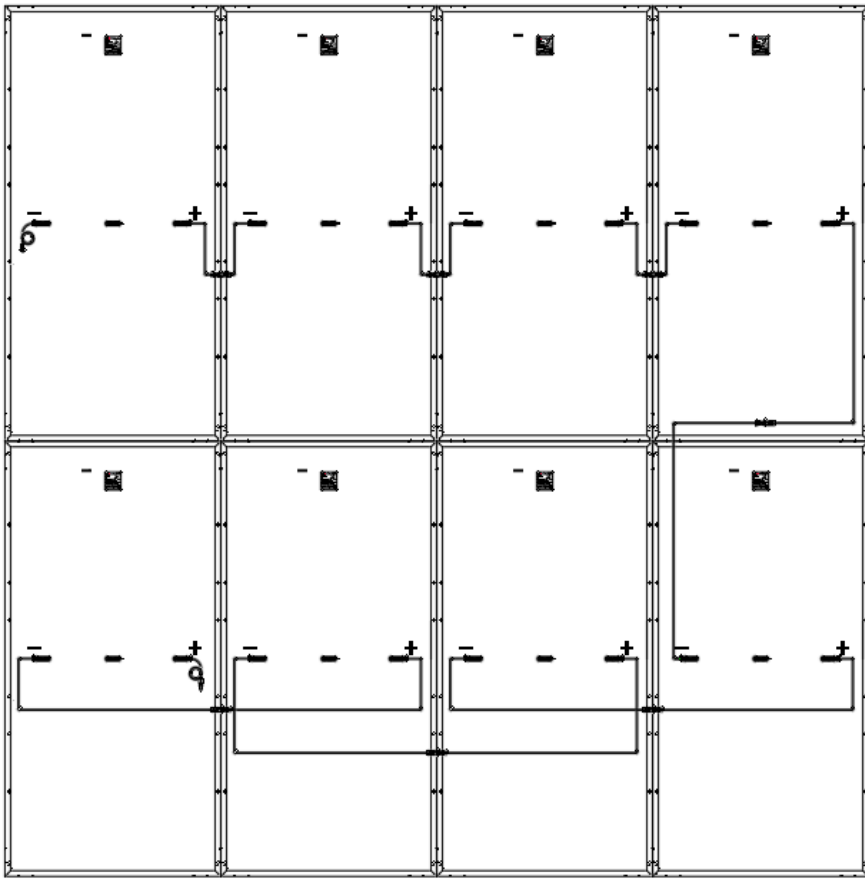

180°

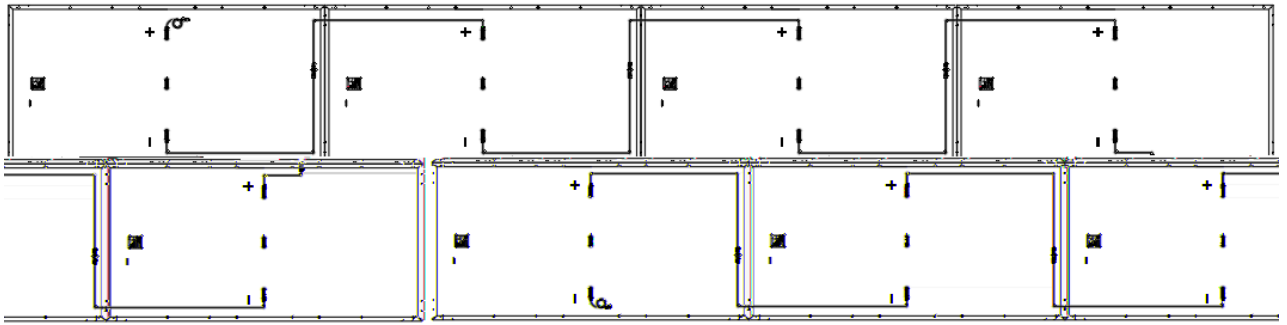

180°

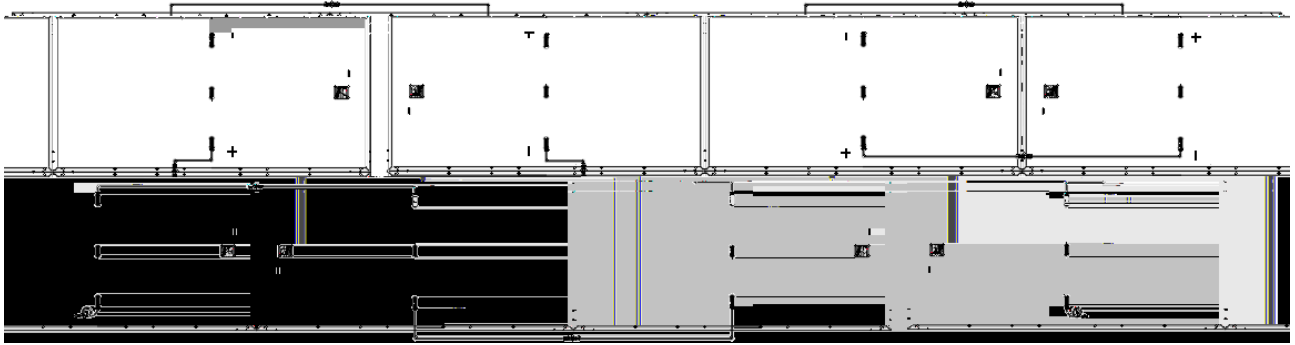



/

SUS 316

1

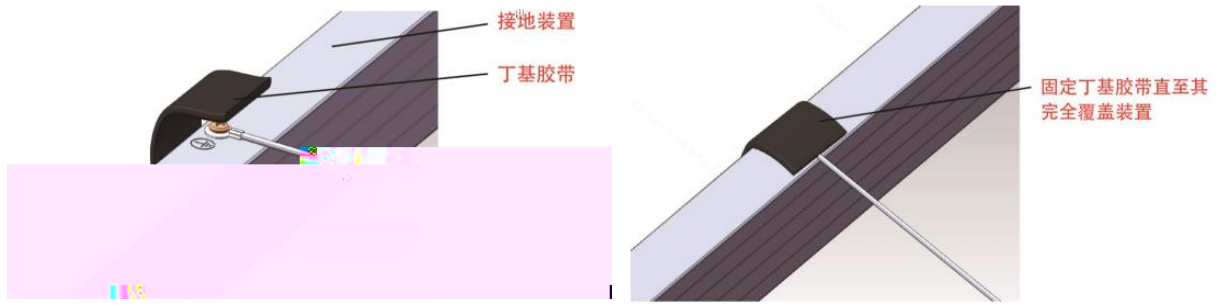

2

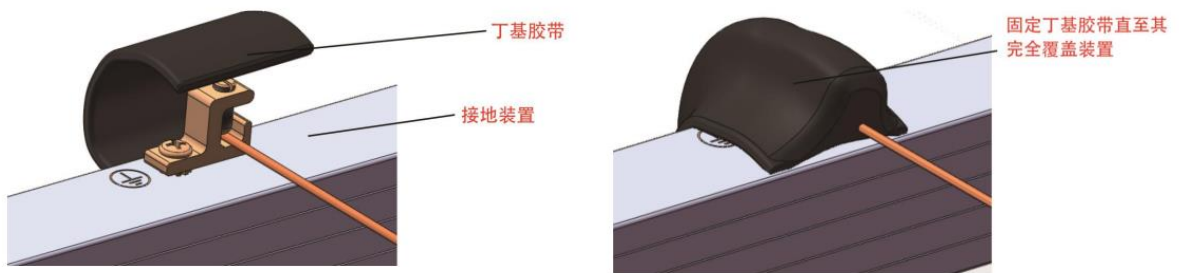

IEC 61701
IEC 61730

- 2

2

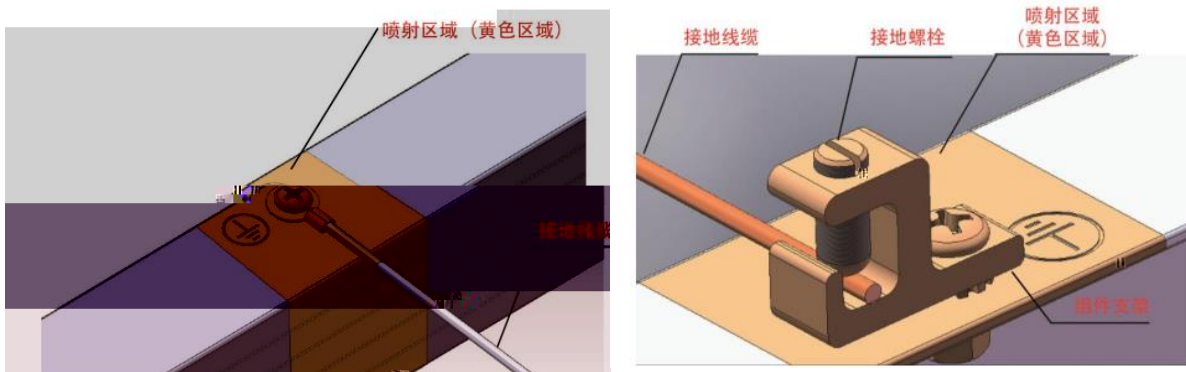

IEC 61701
IEC 61730

- 2



- 1
- 2
- 3
- 4
- 5



